



Thank you for purchasing this Autel diagnostic tool. This tool, manufactured to a high standard will if used according to the instructions and properly maintained give you years of trouble-free performance.



WARNING:

- Serious or fatal crushing injuries can occur from frame tip-over. To prevent this frame from tipping over it must be secured to the ground during the assembly.
- Improper assembly of the calibration frame may result in permanent damage to the frame and may render it inoperable and/or unsafe.

Parts List

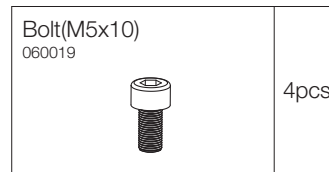
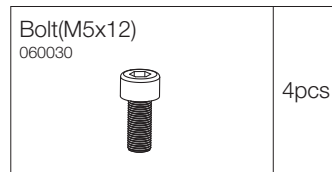
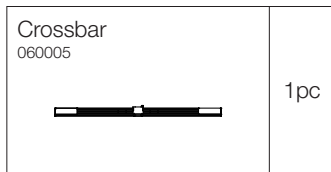

NOTE: Please find the below parts in the Calibration Frame package.

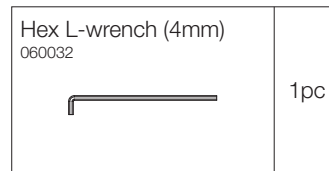
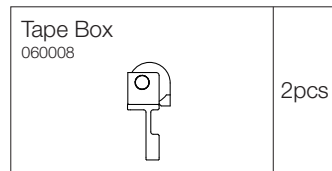
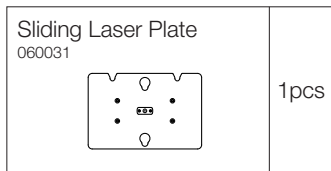

Assemble the Crossbar

1

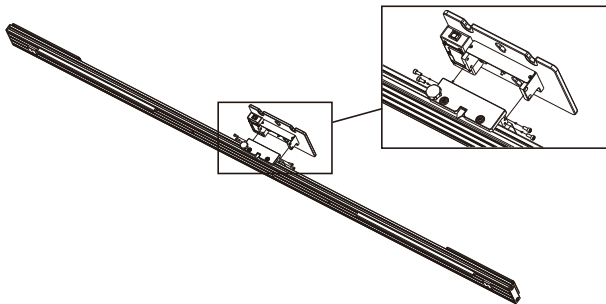

- Take out the Crossbar and the Sliding Laser Plate from the package cartons respectively.
- Attach the Crossbar Sliding Plate to the center of the crossbar, insert bolts (M5x12) on the side view and tighten them with the hex L – wrench (4mm). Ensure the Crossbar Sliding Plate is securely attached to the crossbar.

2

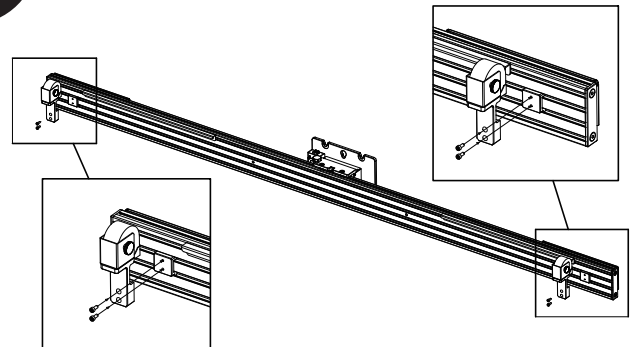

- Take out the tape boxes from the package cartons.
- Insert bolts (M5x10) into the lower segment of the tape box.
- Turn the lower segment of the tape box with bolts to the holes on the crossbar.
- Tighten the bolts with the hex L – wrench (4mm) to attach tape boxes on both ends of the crossbar. Ensure the tape boxes are securely attached.